



## **SUN SAFES MFG. CO.**

Address 391-1 Dokeun-ri Wollong-myun Paju city, Kyounggi-do, Korea

Tel +82 31 945 9300-7

Fax +82 31 945 9400, 0340

Email [info@eaglesafes.com](mailto:info@eaglesafes.com)

[www.eaglesafes.com/en](http://www.eaglesafes.com/en)

[www.lucell.net](http://www.lucell.net)

# INSPIRING PROFESSIONALISM

we  
guarantee  
you  
complete  
peace  
of  
mind



## CONTENTS

Brief History	2
C.E.O Message	3
Company Introduction	5
Certificates	6
Fire & Drop Test / Actual fire accident	7

### FIRE RESISTANT SAFES

Premium Design Safes	8
Compact sized Fire Resistant Safes	10
Design Fire Resistant Safes	12
Medium to Large sized Fire Resistant Safes	14
Special Fire Resistant Safes	16
Fire Resistant Filing Cabinet	18
Burglary & Fire Resistant Safes	20

### SECURITY SAFES

Front Loading Depository Safes	22
Rotary Hopper Safes & Slot Safes	23
Security Money Chests	24
In-floor Safes	25
Hotel Safes / Wall Safes	26
Slot Cash Drawer	27

## BRIEF HISTORY OF SUN SAFES MFG. CO.

1972.06.	Sun Safes Mfg. Co. established
1973.01.	Special Prize awarded at 13th National Goods Exhibition (Prize of Chief of the Supreme Court)
1986.09.	K.S No. 4767_Korean Standard Association
1987.11.	Tower of 1 Million Dollar Export awarded
1992.08.	Excellent Small and Medium Enterprise Designated (Headoffice of the Industrial Bank of Korea)
1996.03.	New Factory Completed (391-1 Dokeun-ri, Wollong-myun, Paju-si, Kyounggi-do 413-811, Republic of KOREA) and Moved
1996.12.	A mark of honor gravestone industrial
1999.12.	UL No. 120699-R18986 approved by Underwriters Laboratories Inc.
2002.08.	MA GA166 - 1997 approved by China National Accreditation of Laboratories
2004.03.	UL No. 100304-R18986A approved by Underwriters Laboratories Inc.
2004.04.	SP No. 38 27 00 approved by Swedish National Testing and Research Institute
2004.09.	No.092104-R18986 approved by Underwriters Laboratories Inc.
2004.09.	UL-1037 No.092104-BP9687 approved by Underwriters Laboratories Inc.
2004.12.	Awarded No.1. 2004 Korea Quality Competitive Power Superior Company in Security Equipment Part.
2005.01.	Inaugurated New President Kim Young Sook.
2005.06.	Korea world's best product award by the Minister of Commerce, Industry and Energy.
2006.11.	Tower of 10 Million Dollar Export awarded
2008.07.	Launched LuCeLL in Korea
2009.02.	Elected "Hi-Seoul brand" of the year 2009, Entered Hyundai Dept. store
2009.07.	LuCeLL, designated as Good Design by Korean Design Center
2010.11.	Selected as Safes supplier for Samsung Group S1(Security No.1), Entered Lotte Dept. store
2012.	"Bronze Tower" Industrial Award
2013.	Excellent Green-Biz certified



Dear customers,

First, we would like to thank you for your interest in Sun Safes Mfg. Co., Korea. Sun Safes was founded in 1972 and has since then earned a reputation for supplying high-quality safes and delivering the very best customer service.

As a leader in the Korean safe market, Sun Safes has, over the years, developed many technologies and accumulated a vast amount of know-how.

We have also played a pivotal role in upgrading the level of Korean safe manufacturing skills to meet international standards and to create new international standards.

We now boast more than 130 partners worldwide, and hope to expand this number even further in the near future.

With an eye toward achieving ultimate customer satisfaction and creating a safer more secure world for all, we will continue to put forth great efforts to develop outstanding products and technologies.

Yours Sincerely,  
CEO & all the staffs



# COMPANY INTRODUCTION

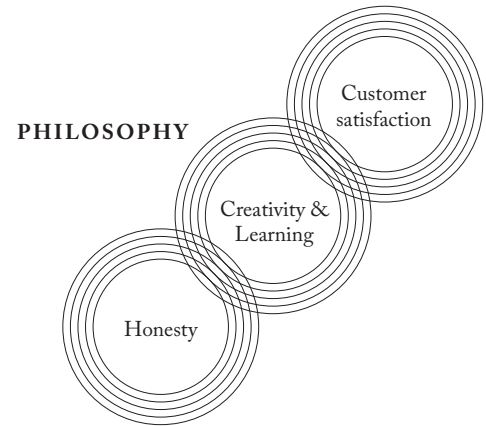

## **From a safe repair man to founder of Sun Safes Mfg. Co.**

Y.H. Kim, the founder of Sun Safes Mfg. Co., was a humble safe repair man when he made up his mind to start his own safe manufacturing company. Mr. Kim realized the sad state of the safe business in Korea, noting that Koreans often used imported safes owing to the low quality of Korean safes. He was determined to improve the quality of Korean safes and set off for the United States in order to learn advanced safe manufacturing technologies. After working as a laborer for 10 years in various safe manufacturing companies and as a locksmith, Mr. Kim returned to Korea armed with the knowledge needed to open his own company, which he did, in 1972, under the name Sun Safes Mfg. Co. and in collaboration with Ms. Y.S. Kim, who is the current president.

## **Transforming Korea from a safe importing country to a safe exporting country**

Mr. Kim first built a test furnace in the factory, with which he continually conducted fire tests on safes. When his safe endured 3 hours and 30 minutes at 980°C, clearly showing its high-quality, many high-ranking government officials and reporters from major broadcasting companies and newspapers were on hand to cover the milestone event. Impressively, Mr. Kim's safes passed the UL class 350 one hour test and the impact test at the same time, a first in Asia. With this achievement as momentum, Mr. Kim went on to lead the Korean safe market, continually developing new kinds of safes to meet customers, diverse needs and eventually transforming Korea from a safe importing country to a safe exporting country.

## **Consistent innovation and renovation in safe manufacturing**

Sun safes has consistently invested in improving its production facilities. The company automated its business plants to quicken business processes, the benefits of which have been felt by customers worldwide. Sun Safes introduced a CO2 laser cutting machine, roll forming machine etc. to enable mass production, and has maintained its efforts to raise productivity. These initiatives have made it possible for the company to offer the highest quality safe products at reasonable prices to more partners around the world.

## **Put the customer first, make premium quality safes, and achieve a win-win business**

Armed with confidence garnered from our past successes and accumulated know-how, Sun Safes' members continually introduce higher standards of quality into the market with new-concept safes that offer ease-of-use and convenience in everyday life. With our 'win-win partnership' philosophy enabling us to see from the customer's point of view, we have built a solid foundation from which to create products that will continue to satisfy the needs of our customers well into the future. Indeed, Sun Safes is an open-minded company that not only welcomes the suggestions of our business partners and customers, but uses these ideas to make our company even stronger.

At Sun Safes, we believe that efforts such as these will contribute to the realization of a 'Comfortable and Secure Life' for all the ultimate goal of the company.



# CERTIFICATES

The superiority of Sun Safes' products has been demonstrated not only by customers but also by world famous authorities in the security industry.

**A SAFE IS NOT JUST A STEEL BOX, BUT A SKILL and A SCIENCE.**

- UL(Underwriters Laboratories Inc.) - UL 72, Fourteenth Edition(Class 350 - 1 hour)
- UL(Underwriters Laboratories Inc.) - UL 1037, Antitheft Alarm and Devices
- SP(Swedish National Testing and Research Institute) - NT-Fire 017 - 60P / 90P / 120P - 60 Diskette, 90 Data
- ISO 9001 (Korea Productivity Center Quality Assurance)
- ISO 14001 (Korea Productivity Center Quality Assurance)
- JIS(Japanese Industrial Standardization) - JIS S 1037 / PR-1T
- KS(Korea Standards Association) - KS G 4500
- GOST POCC KR. C307.B03250 (No. 5589108-5589110)
- EURO GRADE 1 (SS-EN 1143-1, 2005 GRADE 1)



# FIRE & DROP TEST

Fire resistant testing in accordance with KS G 4500, UL-72, SP NT-Fire 017 - 60P / 90P / 120P

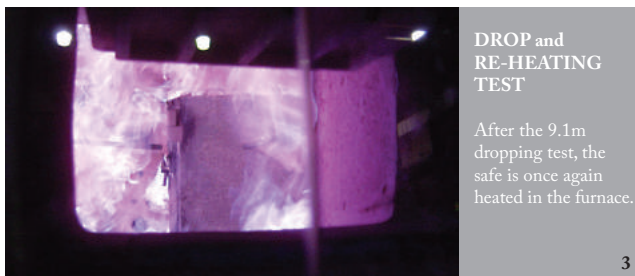

# ACTUAL FIRE ACCIDENT





# PREMIUM DESIGN SAFES

Modern and stylish fire-resistant safes, perfect for home and / or business use that offers superior fire protection for your valuables and important documents.



NPS-031D(W)

NPS-M020(B)



(SL)



(BK)



(BR)



(AP)

- Fire resistant safes with attractive and compact design
- 1 hour fire protection certified by SP NT-Fire 60P and KS 1 hour furnace temperature : 927°C
- The button of electronic lock gets activated only when the customer use it, which is more secure
- Two hefty  $\varnothing$  16(5/8") solid chrome plated locking bolts
- One stationary locking bolt on hinge side to deter prying attack on hinges
- Convenient plastic tray(+ Adjustable shelf for model 031D)
- Pre-drilled anchor hole or rubber feet(16mm) without anchor hole(Optional)
- Motorized-lock is available as an option.



1. Push Start button
2. Input the personal code
3. The door opens with 'Open' sign on the panel
4. Turn the handle to the right and open the door

## DIMENSIONS

Model	Outside(mm)			Inside(mm)			Weight (Kgs)	Outside(inch)			Inside(inch)			Weight (lbs)	Tray / Shelf
	H	W	D	IH	IW	ID		H	W	D	IH	IW	ID		
NPS-M020	344	424	385	245	325	260	40	13 1/2	16 2/3	15 1/6	9 2/3	12 4/5	10 1/4	81	1 / 0
NPS-031D	520	410	445	415	305	320	63	20 1/2	16 1/7	17 1/2	16 1/3	12	12 3/5	125	1 / 1

# UNI-040 with stylish design and smart functions



UNI-040MR



UNI-040NP



UNI-040NB



### EXCELLENT FIRE RESISTANT FUNCTION

- Passed KSG4500 1 hr keeping the inside temperature below 177°C when the outside temperature goes up to 927°C .



### MODERN AND INNOVATIVE DESIGN!

- Stylish safe without handle, key, or rubber buttons for electronic locks
- Innovative combination of steel and reinforced plastic material(ABS) with tighter combination of door and body



### BETTER BURGLAR RESISTANT FUNCTION

- 5 of 4way bolts under motorized locking mechanism
- separated locking module and reinforced locking hole



- Voice instruction (English, Chinese or Japanese, Korean)
- Supersensitive shock sensor with a 120 decibel alarm, which responds to a shock, shift and tilting of the safe
- Motorized locking mechanism does not need manual locking process
- Customer can choose either battery or electronic power with the power terminal on the back of the safe
- Flexible accommodations with multifull shelves or drawers
- Convenient small space where cards, keys or paper files can be put

## DIMENSIONS

Model	Outside(mm)			Inside(mm)			Weight (Kgs)	Outside(inch)			Inside(inch)			Weight (lbs)	Tray / Shelf
	H	W	D	IH	IW	ID		H	W	D	IH	IW	ID		
UNI-040	521	426	472	410	310	315	56	20 1/2	16 7/9	18 4/7	16 1/7	12 1/5	12 2/5	123.4	1/1

\*The height of rubber feet was NOT included into outside dimension.

# COMPACT SIZED FIRE RESISTANT SAFES



YES-M020(WH)

## COLOR OPTIONS (YES only)



## LOCK OPTIONS



Fire-resistant safes perfect for home and / or business use that offer superior fire protection for your valuables and important documents



- High security, fire resistant safes with attractive and compact design
- 1 hour fire protection certified by SP NT-Fire 017 60P, UL Class 350 1 hour, KS 1 hour (Furnace Temperature : 927°C)
- Two hefty  $\varnothing$  16(5/8") solid chrome plated locking bolts
- One stationary locking bolt on hinge side to deter prying attack on hinges
- Convenient plastic tray(+ Adjustable shelf for model 031D )
- Pre-drilled anchor hole or Rubber feet(16mm) without anchor hole(Optional)



SS-031D

## DIMENSIONS

Model	Outside(mm)			Inside(mm)			Weight (Kgs)	Outside(inch)			Inside(inch)			Weight (lbs)	Tray / Shelf
	H	W	D	IH	IW	ID		H	W	D	IH	IW	ID		
- EM-015 SM-015	296	390	320	215	310	215	25	11 2/3	15 1/3	12 3/5	8 1/2	12 1/5	8 1/2	55	1 / 0
YES-M020 EM-020 SM-020	344	424	388	245	325	260	37	13 1/2	16 2/3	15 2/7	9 2/3	12 4/5	10 1/4	81	1 / 0
- ES-020 SS-020	344	480	388	219	355	262	45	13 1/2	18 8/9	15 2/7	8 2/3	14	10 1/4	99	1 / 0
- ES-030 SS-030	480	344	388	355	219	262	45	18 8/9	13 1/2	15 2/7	14	8 2/3	10 1/4	99	1 / 0
YES-031D ES-031D SS-031D	520	410	445	415	305	320	57	20 1/2	16 1/7	17 1/2	16 1/3	12	12 3/5	125	1 / 1

\* EM-015 ~ EM-016 : No Rubber Feet.

\* EM-020 ~ ES-031D : Height of rubber feet(16mm) is included into outside dimensions

FIRE RESISTANT SAFES

# STYLISH DESIGNED FIRE RESISTANT SAFES



EG - 085 (BR)



## DIMENSIONS

Model		Outside(mm)			Inside(mm)			Weight (kgs)	Outside(inch)			Inside(inch)			Weight (lbs)	Tray / Shelf
DIAL	ELECTRONIC	H	W	D	IH	IW	ID		H	W	D	IH	IW	ID		
EGC - 070	EGE - 070	694	552	536	539	397	344	129	27 1/3	21 3/4	21 1/9	21 2/9	15 5/8	13 1/2	284	1 / 1
EGC - 085	EGE - 085	835	581	536	680	426	344	159	32 7/8	22 7/8	21 1/9	26 7/9	16 7/9	13 1/2	350	1 / 1
EGC - 100	EGE - 100	988	581	536	833	426	344	187	38 8/9	22 7/8	21 1/9	32 4/5	16 7/9	13 1/2	412	1 / 2
EGC - 120	EGE - 120	1167	638	675	1012	483	467	278	46	25 1/8	26 4/7	39 5/6	19	18 2/5	612	1 / 2
EGC - 130	EGE - 130	1309	733	675	1154	578	467	325	51 1/2	28 6/7	26 4/7	45 3/7	22 3/4	18 2/5	716	1 / 2
EGC - 170	EGE - 170	1679	733	675	1524	578	467	404	66 1/9	28 6/7	26 4/7	60	22 3/4	18 2/5	890	1 / 3

\* Height of castor(74mm) is included into outside dimensions.

# DESIGN REVOLUTION THAT EMPOWERS SAFE USERS

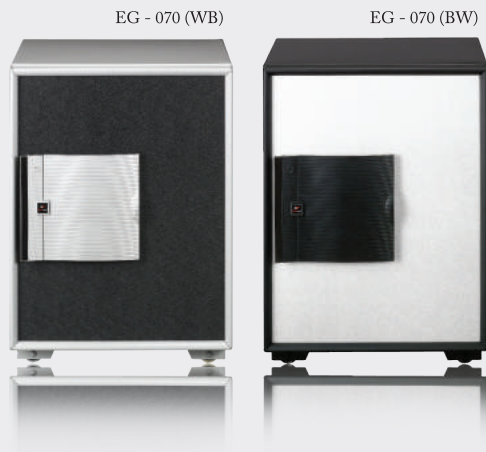

## Modern & Stylish design

Trendy design of the safe fits very well in a variety of home or office interior environments.

## Fire resistant function

This safe has passed KSG4500, keeping the inside temperature below 177°C when the outside temperature goes up to 927°C for 1 hour.

## Enhanced security

With a stronger structure, the safe has better burglar-resistant functions than any other regular fire resistant safe.

## Convenient and secure soft-touch button

Offers easier and better convenience with voice instruction in coordination with touch button - electronic lock mechanisms.

## Options

- Mechanical dial lock or certified electronic lock are available as options.
- The customer can choose either a fixing anchor or wheels in the bottom of the safe.
- Fingerprint lock : A convenient and secure fingerprint lock is available as an option.

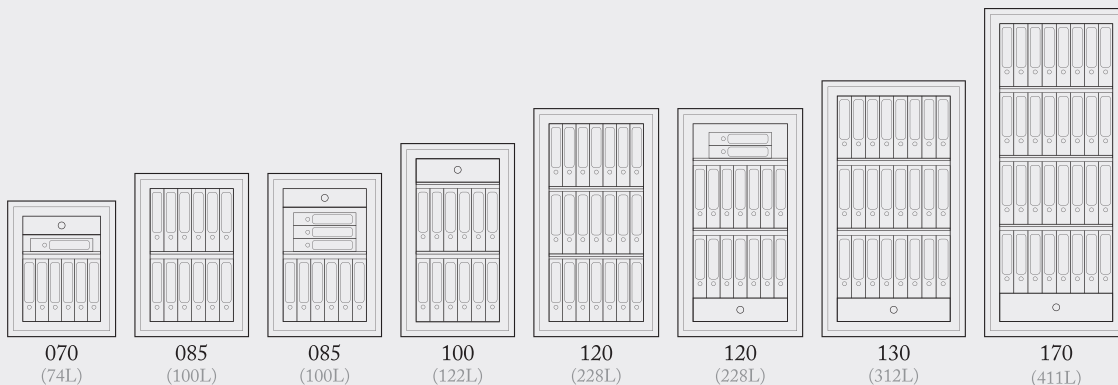

# MEDIUM TO LARGE SIZED FIRE RESISTANT SAFES



ES-100

Ideal for home and / or business use, this fire-resistant safe has enough capacity to hold and protect all of your valuables and important documents from fire



- High security, fire-resistant safes in a variety of sizes with several proven certificates
- 1 hour or 2 hours fire protection certified by KS 1 hour(Furnace Temperature : 927°C) and SP NT-Fire 017 120P(Furnace Temperature : 1049°C)
- Three-way main bolt works with independent reloading device
- Two to three stationary locking bolts on hinge side to deter prying attack on hinges
- Lockable drawer + adjustable shelf
- Wheels for easy moving(Removable wheels are optional.)
- Pre-drilled anchor hole without wheels(Optional)

## LOCK OPTIONS



KX Handle + One key only

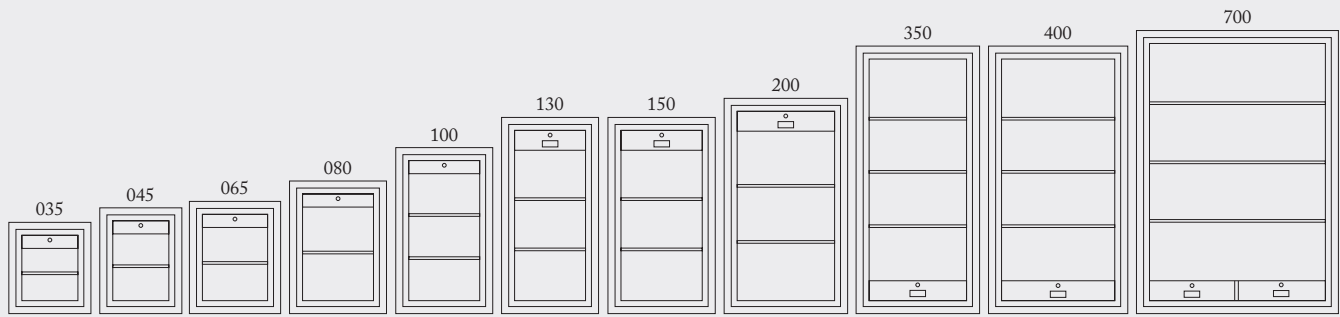

SS-700

## DIMENSIONS

Model	Outside(mm)			Inside(mm)			Weight (Kgs)	Outside(inch)			Inside(inch)			Weight (lbs)	Drawer / Shelf
	H	W	D	IH	IW	ID		H	W	D	IH	IW	ID		
ES-035 SS-035	616	491	467	389	338	304	96	24 1/4	19 1/3	18 2/5	15 1/3	13 1/3	12	211	1 / 1
ES-045 SS-045	703	479	467	475	326	304	105	27 2/3	18 6/7	18 2/5	18 5/7	12 5/6	12	231	1 / 1
ES-065 SS-065	743	549	507	519	398	346	120	29 1/4	21 3/5	20	20 3/7	15 2/3	13 5/8	264	1 / 1
ES-080 SS-080	865	580	507	638	427	346	185	34	22 5/6	20	25 1/8	16 4/5	13 5/8	407	1 / 1
ES-100 SS-100	1066	585	507	833	426	346	200	42	23	20	32 4/5	16 7/9	13 5/8	440	1 / 2
ES-130 SS-130	1245	585	507	1012	426	346	220	49	23	20	39 5/6	16 7/9	13 5/8	484	1 / 2
ES-150 SS-150	1245	642	630	1012	483	463	285	49	25 2/7	24 4/5	39 5/6	19	18 2/9	627	1 / 2
ES-200 SS-200	1356	737	630	1123	578	463	340	53 2/5	29	24 4/5	44 1/5	22 3/4	18 2/9	748	1 / 2
ES-350 SS-350	1671	737	630	1438	578	463	380	65 4/5	29	24 4/5	56 3/5	22 3/4	18 2/9	836	1 / 3
ES-400 SS-400	1671	832	630	1438	673	463	410	65 4/5	32 3/4	24 4/5	56 3/5	26 1/2	18 2/9	902	1 / 3
ES-700 SS-700	1769	1206	654	1536	1047	487	670	69 2/3	47 1/2	25 3/4	60 1/2	41 2/9	19 1/6	1474	2 / 3

\* Height of castor(74mm) is included into outside dimensions.



# SPECIAL FIRE RESISTANT SAFES



EDS-100

## DATA MEDIA SAFES DIMENSIONS

Model	Outside(mm)			Inside(mm)			Weight (Kgs)	Outside(inch)			Inside(inch)			Weight (lbs)	Shelf
	H	W	D	IH	IW	ID		H	W	D	IH	IW	ID		
EDS-020 DS-020	360	480	388	103	239	140	48	14 1/6	18 8/9	15 2/7	4	9 2/5	5 1/2	123	0
EDS-035 DS-035	616	491	467	277.4	226.4	167.2	105	24 1/4	19 1/3	18 2/5	11	9	6 4/7	242	1
EDS-045 DS-045	703	479	467	364.4	214.4	167.2	116	27 2/3	18 6/7	18 2/5	14 1/3	8 4/9	6 4/7	255	1
EDS-065 DS-065	743	549	507	404	284	210	141	29 1/4	21 3/5	20	16	11 1/6	8 1/4	308	2
EDS-080 DS-080	865	580	507	526	315	210	215	34	22 5/6	20	20 5/7	12 2/5	8 1/4	374	2
EDS-100 DS-100	1066	585	507	728	315	210	241	42	23	20	28 2/3	12 2/5	8 1/4	506	3
EDS-150 DS-150	1245	642	630	906	377	333	315	49	25 2/7	24 4/5	35 2/3	14 5/6	13	693	3
EDS-200 DS-200	1356	737	630	1017	472	333	340	53 2/5	29	24 4/5	40	18 4/7	13	748	3
EDS-350 DS-350	1671	737	630	1332	472	333	500	65 4/5	29	24 4/5	52 4/9	18 4/7	13	1100	3
EDS-400 DS-400	1671	832	630	1332	567	333	550	65 4/5	32 3/4	24 4/5	52 4/9	22 1/3	13	1210	3
EDS-700 DS-700	1769	1206	654	1430	941	357	700	69 2/3	47 1/2	25 3/4	56 2/7	37	14	1540	3

\* EDS-020 ~ EDS-031D : Height of rubber feet(16mm) is included into outside dimensions.

\* EDS-035 ~ EDS-700 : Height of castor(74mm) is included into outside dimensions.

# DATA MEDIA

Designed to protect sensitive magnetic storage media from fire, humidity, dust etc

# SAFE IN SAFES

Combines the qualities of a record safe with those of an inner security safe for maximum security

- Variable, suitable for all data media(CD, computer media, magnetic tapes etc.)
- 1 hour or 2 hours fire protection certified by KS 1hour and SP NT-Fire 120P
- Data certificate - 60 Diskette, 90 Data(Data media safes only)
- Multi-layer inner box of special anti-thermal materials(Data media safes only)
- Three-way main bolt works with independent relocking device
- Two to three stationary locking bolts on hinge side to deter prying attack on hinges
- Wheels for easy moving(Removable wheels are optional.)
- Steel thickness of money chest : Body 6mm, Door 9mm(Safe in safes only)

## LOCK OPTIONS

- EK 
- CK 
- KK 
- KX Handle + One key only



SIS-100CC

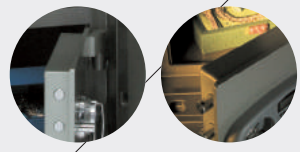

## SAFE IN SAFES DIMENSIONS

Model	Outside(mm)			Inside(mm)			Weight (Kgs)	Outside(inch)			Inside(inch)			Weight (lbs)	Shelf		
	H	W	D	IH	IW	ID		H	W	D	IH	IW	ID				
SIS-080CC SIS-080EE	865	580	507	MC	288	410	221	220	34	22 5/6	20	MC	11 1/3	16 1/7	8 5/7	482	1
				SS	338	427	346					SS	13 1/3	16 4/5	13 5/8		
SIS-100CC SIS-100EE	1066	585	507	MC	288	410	221	235	42	23	20	MC	11 1/3	16 1/7	8 5/7	515	2
				SS	533	426	346					SS	21	16 7/9	13 5/8		
SIS-130CC SIS-130EE	1245	585	507	MC	288	410	221	255	49	23	20	MC	11 1/3	16 1/7	8 5/7	559	2
				SS	712	426	346					SS	28	16 7/9	13 5/8		
SIS-150CC SIS-150EE	1245	642	630	MC	288	472	310	330	49	25 2/7	24 4/5	MC	11 1/3	18 4/7	12 1/5	724	2
				SS	712	483	463					SS	28	19	18 2/9		
SIS-200CC SIS-200EE	1356	737	630	MC	288	564	338	395	53 2/5	29	24 4/5	MC	11 1/3	22 1/5	13 1/3	867	2
				SS	823	578	463					SS	32 2/5	22 3/4	18 2/9		
SIS-350CC SIS-350EE	1671	737	630	MC	288	564	338	435	65 4/5	29	24 4/5	MC	11 1/3	22 1/5	13 1/3	955	3
				SS	1138	578	463					SS	44 4/5	22 3/4	18 2/9		
SIS-400CC SIS-400EE	1671	832	630	MC	288	660	338	475	65 4/5	32 3/4	24 4/5	MC	11 1/3	26	13 1/3	1043	3
				SS	1138	673	463					SS	44 4/5	26 1/2	18 2/9		

\* Height of castor(74mm) is included into outside dimensions.

\* MC - Inside money chest

\* SS - Shelf space above money chest

# FIRE RESISTANT FILING CABINET



SF-680-4DKK



SF-680-3EKK



SF-680-2XKK

## LOCK OPTIONS

EX		
	Crown	V4
DX		
	Elbo	S&G
KX		
	Dimple	Mountain

## FILING CABINET

Offers smooth and quiet suspension filing system to protect your important documents from fire and robbery

- 1.5 hours fire protection certified by SP NT-Fire 017 90P(Furnace Temperature : 1010°C)
- Adjustable hanger files accommodate foolscap, letter and legal size documents
- Selective Locking System: Permits locking of any of the 4 drawers either independently or collectively
- Master Drawer Cam on the top drawer controls the lower drawers
- Each drawer is capable of carrying close to 100Kgs of files, way beyond the standard requirement
- Wheels for easy moving(Optional)
- Each compartment has individual protection in case of fire, even if one of the drawer is open





**HANGER BAR  
ADJUSTABLE  
HANGER BARS**  
Can accommodate A4, Legal,  
and Letter size paper.

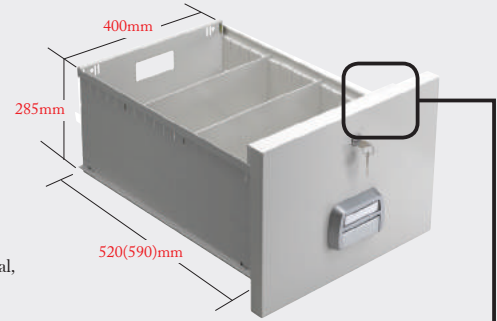

**SELECTIVE MASTER  
LOCKING SYSTEM**  
Controls to lock the drawers  
independently or collectively.



## LOCK OPTIONS

depth of drawer  
SF680 : 680mm(26 3/4")  
SF750 : 750mm(29 1/2")

# SF680-4DKK

Qty of drawers

Main lock on the top drawer(dial/E-lock/key lock)

Key lock on the top drawer

Key locks on the lower drawers

### • LOCK OPTIONS FOR TOP DRAWER

- DK(EK) combination dial(e-lock)+key
- DX(EX) combination dial(e-lock) only
- KX one key lock only
- TK two key locks

### • LOCK OPTIONS FOR LOWER DRAWER

- K key locks
- X no lock



SF680-4EX



SF680-4DKX



SF680-4XKK



SF680-4XKX



SF680-4TKK

## DIMENSIONS

Model	Outside(mm)			Inside(mm)			Weight (Kgs)	Outside(inch)			Inside(inch)			Weight (lbs)	
	H	W	D	IH	IW	ID		H	W	D	IH	IW	ID		
SF680-	2	852	528	678	316	430	542	155	33 1/2	20 4/5	26 2/3	12 4/9	17	21 1/3	342
	3	1216	528	678	316	430	542	215	47 7/8	20 4/5	26 2/3	12 4/9	17	21 1/3	474
	4	1580	528	678	316	430	542	275	62 1/5	20 4/5	26 2/3	12 4/9	17	21 1/3	606
SF750-	2	852	528	748	316	430	612	170	33 1/2	20 4/5	29 4/9	12 4/9	17	24	374
	3	1216	528	748	316	430	612	230	47 7/8	20 4/5	29 4/9	12 4/9	17	24	507
	4	1580	528	748	316	430	612	290	62 1/5	20 4/5	29 4/9	12 4/9	17	24	639

\* Height of castor(74mm) is included into outside dimensions.

# BURGLARY & FIRE RESISTANT SAFES



SB-02C



SBE-02K



SBS-1100CC

## LOCK OPTIONS



**SB** U.L. RATED  
BURGLARY/  
FIRE SAFES

The best choice to protect your property  
from fire and burglary



- 1 hour fire protection and premium security(UL Class 350 1 hour, UL 1037 RSC)
- Heavy duty composite construction - 2" thick door and 3" thick body
- Independent glass re-locking device
- Three stationary locking bolts on hinge side to deter prying attack on hinges
- Heavy duty steel hinge
- 3 spoke chrome-plated vault handle
- Reinforced composite body with concrete and steel mesh(Optional)
- Pre-drilled anchor hole(Optional)



## SB SERIES DIMENSIONS

Model	Outside(mm)			Inside(mm)			Weight (Kgs)	Outside(inch)			Inside(inch)			Weight (lbs)	Shelf	UL 1 hour	UL RSC
	H	W	D	IH	IW	ID		H	W	D	IH	IW	ID				
SB-01E SB-01C	450	450	520	305	305	318	75	17 5/7	17 5/7	20 1/2	12	12	12 1/2	165	1	*	*
SB-02E SB-02C	685	508	520	540	363	327	168	27	20	20 1/2	21 1/4	14 2/7	12 7/8	370	2	*	*
SB-03E SB-03C	845	508	578	700	363	385	276	33 1/4	20	22 3/4	27 5/9	14 2/7	15 1/6	607	2		*
SB-04E SB-04C	845	710	737	700	565	544	360	33 1/4	28	29	27 5/9	22 1/4	21 3/7	792	2		*
SB-05E SB-05C	1054	710	737	910	565	544	420	41 1/2	28	29	35 5/6	22 1/4	21 3/7	924	2		*
SB-06E SB-06C	1505	710	737	1361	565	544	480	59 1/4	28	29	53 4/7	22 1/4	21 3/7	1056	3		*

# SBE

**EURO GRADE 1  
BURGLARY/  
FIRE SAFES**

Stronger and upgraded version to protect your property from fire and burglary



- Premium security(SS-EN1143-1 : 2005 GRADE 1)
- 1 hour fire protection(SP NT-Fire 017 60P)
- Heavy duty construction - 2" thick door and 3" thick body
- Reinforced composite body with concrete and steel mesh
- Independent glass re-locking bolts on hinge side to deter prying attack on hinges
- Three stationary locking bolts on hinge side to deter prying attack on hinges
- Heavy duty steel hinge and 3 spoke chrome-plated vault handle
- Pre-drilled anchor hole(Optional)



### LOCK OPTIONS

C	Certified combination dial
E	Certified electronic lock
K	Certified bitted key lock

## SBE SERIES DIMENSIONS

Model	Outside(mm)			Inside(mm)			Weight	Outside(inch)			Inside(inch)			Weight (lbs)	Shelf
	H	W	D	IH	IW	ID		H	W	D	IH	IW	ID		
SBE-02E SBE-02K	685	508	524	540	363	327	283	27	20	20 5/8	21 1/4	14 2/7	12 7/8	624	2
SBE-D2E SBE-D2K	685	545	593	540	400	400	342	27	21 1/2	23 1/3	21 1/4	15 3/4	15 3/4	754	2
SBE-03E SBE-03K	845	508	582	700	363	385	380	33 1/4	20	23	27 5/9	14 2/7	15 1/6	838	2
SBE-04E SBE-04K	845	710	741	700	565	544	590	33 1/4	28	29 1/6	27 5/9	22 1/4	21 3/7	1301	2
SBE-05E SBE-05K	1054	710	741	909	565	544	690	41 1/2	28	29 1/6	35 4/5	22 1/4	21 3/7	1521	2
SBE-06E SBE-06K	1505	710	741	1361	565	544	900	59 1/4	28	29 1/6	53 4/7	22 1/4	21 3/7	1984	3

# SBS

**SUPER  
STRONG  
SAFES**

Specially designed to have strong tolerance against hammers and high-pressure drilling; also fire-resistant



- Heavy-duty frame and wall construction for structural integrity
- Hardened plate in door resists modern high-pressure drilling & cutting tools
- Two-way strong live bolt work with independent relocking device
- Alarm system equipped as a basic specification
- Wheels for easy moving(Removable wheels are optional)
- Steel thickness of Money Chest : Body 6mm / Door 9mm

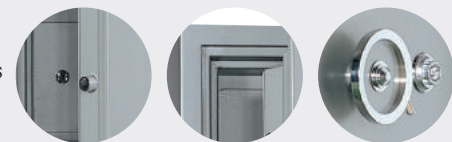

## SBS SERIES DIMENSIONS

Model	Outside(mm)			Inside(mm)			Weight (Kgs)	Outside(inch)			Inside(inch)			Weight (lbs)	Shelf		
	H	W	D		IH	IW		ID	H	W	D		IH			IW	ID
SBS-900CC SBS-900EE	820	620	600	MC	278.9	420	321	380	35 4/5	24	24	MC	11	16 1/2	12 5/8	838	1
				SS	327	420	371					SS	12 6/7	16 1/2	14 3/5		
SBS-1100CC SBS-1100EE	1020	620	600	MC	278.9	420	321	410	43 5/8	24	24	MC	11	16 1/2	12 5/8	904	2
				SS	527	420	371					SS	20 3/4	16 1/2	14 3/5		
SBS-1300CC SBS-1300EE	1220	680	700	MC	278.9	480	421	570	51 3/5	27	28	MC	11	18 8/9	16 5/9	1257	2
				SS	727	480	471					SS	28 3/5	18 8/9	18 1/2		
SBS-1400CC SBS-1400EE	1320	770	700	MC	278.9	570	420.5	630	55 1/2	30	28	MC	11	22 4/9	16 5/9	1389	3
				SS	826.7	570	470.5					SS	32 5/9	22 4/9	18 1/2		
SBS-1600CC SBS-1600EE	1515	770	750	MC	278.9	570	471	730	63 2/5	30	30	MC	11	22 4/9	18 1/2	1609	3
				SS	1027	570	521					SS	40 3/7	22 4/9	20 1/2		
SBS-1700CC SBS-1700EE	1620	840	750	MC	278.9	640	471	820	67 1/3	33	30	MC	11	25 1/5	18 1/2	1808	3
				SS	1127	640	521					SS	44 1/3	25 1/5	20 1/2		
SBS-1800CC SBS-1800EE	1720	1210	750	MC	278.9	1010	471	1030	71 1/4	48	30	MC	11	39 3/4	18 1/2	2271	3
				SS	1227	1010	521					SS	48 2/7	39 3/4	20 1/2		

\* Height of castor(74mm) is included into outside dimensions.

\* MC - Inside money chest

\* SS - Shelf space above money chest

\* Steel thickness of money chest - Body 6mm / Door 9mm

# FRONT LOADING DEPOSITARY SAFES

The ideal safe when immediate deposits and secure storage of cash or other valuables are needed

- B-rated burglary construction(1/2" solid steel door and 1/4" solid steel body)
- Front loading deposit door with anti-fish baffles
- All sides seamlessly welded
- Armed with drill resistant steel hard plate construction
- Three-way main bolt work with independent relocking device(SDS series)
- Full length locking bar to deter prying attack on hinges
- 4 anchor holes on the bottom
- Interchangeable doors(double door models) – ex> Key operated doors can easily be changed to combination lock doors

## LOCK OPTIONS



S782EE



SDS-01E

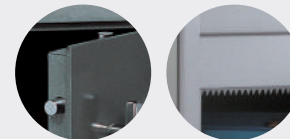

S1C-3020

\* Top Interior compartment with key lock secures deposits (9"H x 19"W x 16"D)

\* Drop Slot Closed: 4"H x 17"W; Usable opening: 3 1/2"H x 16 1/2"W x 8"D



S3D-3020





\* Three individual top depositaries allow users to separate deposits (3" x 4 7/8" x 7" each hopper size)

\* Three steel collection trays in top area (4 5/8"H x 4 5/8"W x 10"D)

## DIMENSIONS

Model	Outside(mm)			Inside(mm)			Front Loading(mm)		Weight (Kgs)	Outside(inch)			Inside(inch)			Front Loading(inch)		Weight (lbs)	door
	H	W	D	IH	IW	ID	H	W		H	W	D	IH	IW	ID	H	W		
S747E S747C	470	380	260	276	368	200	120	290	42	18 1/2	15	10 1/4	10 6/7	14 1/2	7 7/8	4 5/7	11 3/7	93	1
S752E S752C	515	400	400	274	388	325	120	330	67	20 2/7	15 3/4	15 3/4	10 4/5	15 2/7	12 4/5	4 5/7	13	147	1
S782EE S782CC	820	400	400	579	388	325	120	330	87	32 2/7	15 3/4	15 3/4	22 4/5	15 2/7	12 4/5	4 5/7	13	192	2
SDS-01E SDS-01C	480	340	380	247	328	307	120	280	51	18 8/9	13 2/5	15	9 5/7	13	12	4 5/7	11	112	1
SDS-02E SDS-02C	698.5	340	431.8	466	328	358	120	280	76	27 1/2	13 2/5	17	18 1/3	13	14	4 5/7	11	168	1
SDS-03EE SDS-03CC	990.6	514.5	558.8	758	502.5	485.6	120	330	152	39	20 1/4	22	29 5/6	19 7/9	19 1/8	4 5/7	13	334	2
S1E-3020 S1C-3020	761	507	507.5	549	499	437	102	432	105	30	20	20	21 3/5	19 2/3	17 1/5	4	17	231	1
S3E-3020 S3D-3020	761	507	406	521	499	336	102	134	100	30	20	16	20 1/2	19 2/3	13 2/9	4	5 2/7	220	2

# ROTARY HOPPER SAFES & SLOT SAFES

<p>Convenient and safe way to protect money when immediate deposit is required</p> <ul style="list-style-type: none"> <li>• B-rated burglary construction(1/2" solid steel door and 1/4" solid steel body)</li> <li>• Ease-of-use : Deposits are made through the deposit opening or slot, no need to unlock the door</li> <li>• Large capacity hopper area accommodates money bags, envelopes and packages</li> <li>• Large slot size designed to fit standard envelopes</li> <li>• Deposits protected with anti-fish baffles</li> <li>• All sides seamlessly welded</li> <li>• Armed with drill resistant steel hard plate construction</li> <li>• Full length locking bar to deter prying attack on hinges with independent re-locking device</li> <li>• 4 anchor holes on the bottom</li> <li>• Interchangeable Doors – key operated doors will change to combination lock door with ease</li> </ul>	<p><b>LOCK OPTIONS</b></p> <p>EX </p> <p>CX </p> <p>KX </p> <p>C </p> <p>K </p>
--	--



RE-01

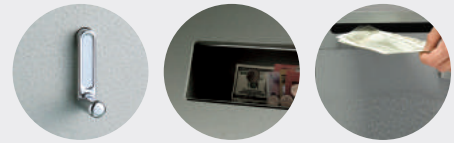

\*\* Features of Under-counter safes  
 - Adaptable for multi-installation use in concrete, masonry, truck, after-sales service vehicles, caravans and etc.



DS-1D

## DIMENSIONS

Model	Outside(mm)			Inside(mm)			Front Loading Slot(mm)		Weight (Kgs)	Outside(inch)			Inside(inch)			Front Loading Slot(inch)		Weight (lbs)	door
	H	W	D	IH	IW	ID	H	W		H	W	D	IH	IW	ID	H	W		
RE-01 RC-01	622	267	368	459	255	299	229	100	62	24 1/2	10 1/2	14 1/2	18	10	11 3/4	9	4	136	1
REE-02 RCC-02	890	337	368	711	325	301	229	100	96	35	13 1/4	14 1/2	28	12 4/5	11 3/4	9	4	212	2
SEE-02 SCC-02	711	337	368	641	325	299	22	201	79	28	13 1/4	14 1/2	25 1/4	12 4/5	11 3/4	6/7	8	174	2
MS-1K MS-1D	305	152	203	252	140	141	10	140	15.3	12	6	8	10	5 1/2	5 5/9	2/5	5 1/2	34	1
MS-2K MS-2D	203	152	305	151	140	254	10	140	15.3	8	6	12	6	5 1/2	10	2/5	5 1/2	34	1
DS-1K DS-1D	305	203	254	252	191	197	10	191	21.3	12	8	10	10	7 1/2	7 3/4	2/5	7 1/2	47	1



# SECURITY MONEY CHESTS

Provide unsurpassed protection of your valuables from unauthorized access

- B-rated burglary construction(1/2" solid steel door and 1/4" solid steel body)
- Heavy duty hinges and all sides seamlessly welded
- Armed with drill resistant steel hard plate construction
- Hefty solid chrome plated locking bolt with independent re-locking device
- Full length locking bar to deter prying attack on hinges
- 4 anchor holes on the bottom
- Adjustable shelf

## LOCK OPTIONS



S852C

## DIMENSIONS

Model	Outside(mm)			Inside(mm)			Weight (Kgs)	Outside(inch)			Inside(inch)			Weight (lbs)	Shelf
	H	W	D	IH	IW	ID		H	W	D	IH	IW	ID		
S838E S838C	380	400	320	363	388	245	58	15	15 3/4	12 3/5	14 2/7	15 2/7	9 2/3	128	1
S852E S852C	515	400	460	498	388	385	73	20 2/7	15 3/4	18 1/9	19 3/5	15 2/7	15 1/6	161	1
S854E S854C	535	485	575	518	473	500	97	21	19	22 2/3	20 2/5	18 5/8	19 2/3	213	1
S874E S874C	740	485	575	723	473	500	123	29 1/7	19	22 2/3	28 1/2	18 5/8	19 2/3	271	1
S894E S894C	940	585	610	923	573	535	165	37	23	24	36 1/3	22 5/9	21	363	2

# IN-FLOOR SAFES

The smartest way to conceal and keep your valuables without others' knowing the safe's location

- In-floor safe designed for installation in concrete
- B-rated burglary construction(1/2" solid steel door and 1/4" solid steel body)
- Heavy duty hinges(Coil spring makes it easy to open and close the door)
- All sides seamlessly welded
- Armed with drill resistant steel hard plate construction
- Hefty solid chrome plated locking bolt with independent re-locking device
- Full length locking bar to deter prying attack on hinges
- Steel dust cover included for flush floor installation and concealment
- 9" x 11" door opening
- Various sizes available according to customer preference

## LOCK OPTIONS

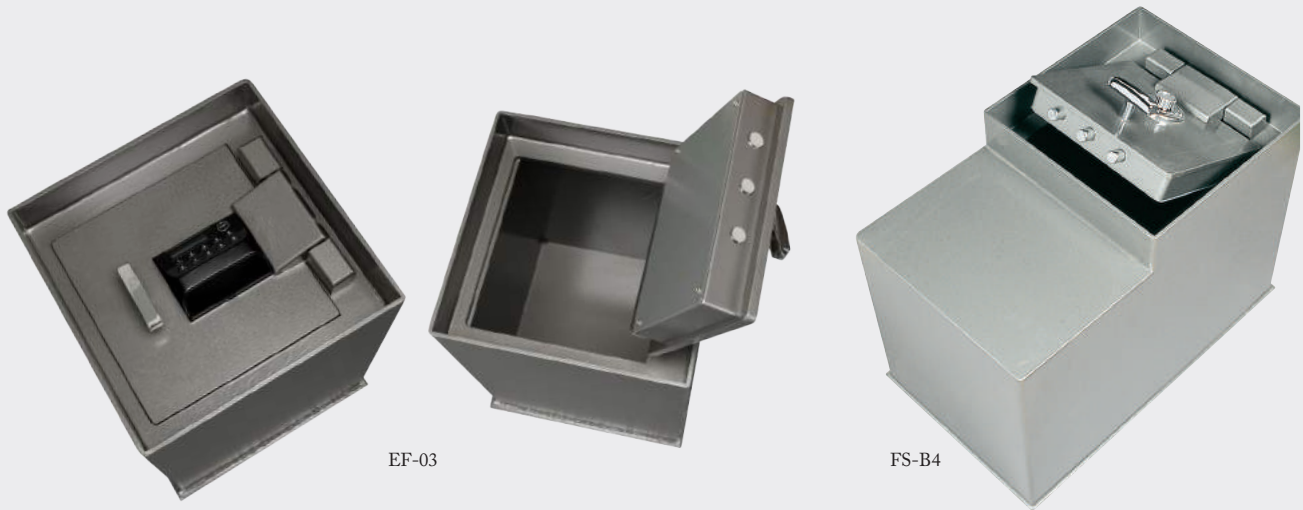

## DIMENSIONS

Model	Outside(mm)			Inside(mm)			Weight (Kgs)	Outside(inch)			Inside(inch)			Weight (lbs)
	H	W	D	IH	IW	ID		H	W	D	IH	IW	ID	
EF - 01 FS - B1	310	376	376	188	344	344	51	12 1/5	14 4/5	14 4/5	7 2/5	13 1/2	13 1/2	112
EF - 02 FS - B2	410	376	376	288	344	344	60	16 1/7	14 4/5	14 4/5	11 1/3	13 1/2	13 1/2	132
EF - 03 FS - B3	516	376	376	394	344	344	68	20 1/3	14 4/5	14 4/5	15 1/2	13 1/2	13 1/2	150
EF - 04 FS - B4	457	630	376	335	598	344	72	18	24 4/5	14 4/5	13 1/5	23 1/2	13 1/2	158

# HOTEL SAFES

Specifically designed to protect valuables at home and in hotels and hospitals

- Light duty steel safes ideal for use as guest room safes, pistol safes or laptop safes
- Easy to use electronic lock(6 digital PIN code for guest)
- Electronic override code for manager
- Mechanical override key for emergencies(Optional)



EHK-10

## DIMENSIONS

Model	Outside(mm)			Inside(mm)			Weight (Kgs)	Outside(inch)			Inside(inch)			Weight (lbs)	Shelf
	H	W	D	IH	IW	ID		H	W	D	IH	IW	ID		
EH - 05	270	360	270	265.4	355.4	219	17	10 5/8	14 1/6	10 5/8	10 4/9	14	8 5/8	37	0
EH - 10	540	360	455	535.4	355.4	404	39	21 1/4	14 1/6	18	21	14	16	86	1
EHK - 10	270	416.6	413.6	255.4	412	355.6	26.6	10 5/8	16 2/5	16 2/7	10	16 2/9	14	59	0

# WALL SAFES

In-wall safe designed to be concealed behind a picture or mirror

- Hidden hinges and a removable shelf
- Depth can be adjusted according to customer preference
- Two hefty  $\varnothing 19(3/4)$ " solid chrome plated locking bolts
- High security dimple key which retracts the bolts
- 1/4" thick solid steel door and 1/16" thick solid steel body
- Depth can be adjusted according to customer preference



EW-01

## DIMENSIONS

Model		Outside(mm)			Inside(mm)			Weight (Kgs)	Outside(inch)			Inside(inch)			Weight (lbs)	Shelf
		H	W	D	IH	IW	ID		H	W	D	IH	IW	ID		
EW - 01	SW - 01	352	432	141	300	371	92	13.5	13 6/7	17	5 5/9	11 4/5	14 3/5	3 5/8	30	1
EW - 01M	SW - 01M	352	421	141	300	360	92	13.2	13 6/7	16 4/7	5 5/9	11 4/5	14 1/6	3 5/8	29	1
EW - 01M(4")	SW - 01M(4")	352	421	107.5	300	360	58.5	12.7	13 6/7	16 4/7	4 1/4	11 4/5	14 1/6	2 1/3	28	1
EW - 02	SW - 02	230	373	190	211.8	340.8	144	9.6	9	14 2/3	7 1/2	8 1/3	13 3/7	5 2/3	21	1
EW - 02M(4")	SW - 02M(4")	230	362	107.5	211.8	329.8	61.5	8.5	9	14 1/4	4 1/4	8 1/3	13	2 3/7	19	1
EW - 03	SW - 03	290	373	196	272.8	340.8	145.4	18	11 3/7	14 2/3	7 5/7	10 3/4	13 3/7	5 5/7	40	1

# SLOT CASH DRAWER

Simple and convenient drawer safe for your shop counter

- Modern and stylish design for high class store
- Automatic and smooth suspension(Push open type)
- 0.7mm solid steel body
- 2 dial(1 wheel) and 1 key system
- Electronic system(optional)



SC-300  
(\* 2014.4.15-)

## DIMENSIONS

Model	Outside(mm)			Weight (kgs)	Outside(inch)			Weight (lbs)
	H	W	D		H	W	D	
SC-300	155	366	249	4	6 1/9	14 2/5	9 4/5	9
SC-2000	160	330	415	5	6 2/7	13	16 1/3	11
SC-3000	205	330	415	5.5	8	13	16 1/3	12